



Product Name: GM-48W GNSS Receiver (USB)

Part Number: GM-48W-A1UA-1BN

Features:

- GPS/Glonass/QZSS/SBAS Satellite Systems Supported
- Excellent Sensitivity Performance and Positioning Accuracy
- NMEA 0183 V4.0 Supported via USB
- SBAS Supported including WAAS/EGNOS/MSAS
- Compact, Rugged Housing Design, with IPX7 Waterproof Rating

Applications:

- Vehicle Tracking
- Asset Tracking

GM-48W GNSS Receiver (USB)

MODEL: GM-48W-A1UA-1BN

WI-RD-D-236 V1.1

I. Specifications:

Category	Specifications	
Application Band	L1(GPS)	GLONASS
Frequency(MHz)	1575.42	1602.00
Efficiency(%)	39.99	30.83
Average Gain(dBi)	-3.98	-5.11
Peak Gain(dBi)	1.81	1.08
VSWR	< 2	
Return loss	< -10	
Test Condition	With housing	
Impedance	50Ω	
Polarization	RHCP	
Physical Construction		
Dimension	56mm (Diameter) x 21.5 mm (Height)	
Weight	80 grams without cable	
Case Material	Fully gasketed high-impact plastic, waterproof to IEC 60529 IPX7 standards	
Environmental Conditions		
Temperature	Operating: -30 ~ +80 °C	
	Storage: -40 ~ +80 °C	
ESD Protection (IEC 61000-4-2 level 4)	±8 KV (direct discharge) ±15 KV (air discharge)	
Communication		
Protocol	NMEA 0183 V4.0	
Interface	USB	
Interface Capability		
Output Sentences (Optional)	GGA(1sec), GLL(1sec), GSA(1sec), GSV(1sec), RMC(1sec), VTG(1sec)	

© San Jose Technology, Inc.
All specifications subject to change without notice.

Baud Rate	9600bps
Performance	
Built in Antenna element	High-reliability ceramic patch
Receiver type	GPS L1C/A GLONASS L1OF SBAS L1C/A QZSS L1C/A
Channels	72 parallel
Sensitivity*	-164dBm
SBAS	WAAS, EGNOS, MSAS
TTFF**	Hot start 1 sec. Typical Cold start 26 sec. Typical
Position accuracy**	2.5 m
Velocity accuracy ***	0.05 m/s
Update Rate(Optional)	1Hz
Input Voltage	5V
Power Consumption	Typical 75mA

© San Jose Technology, Inc.
All specifications subject to change without notice.

*All satellites at -130 dBm · Use u-blox u-center test

**CEP, 50%, 24 hours static, -130 dBm, > 6 SVs

*** 50% @ 30 m/s

II. Antenna Technical Parameters:

S-parameters:

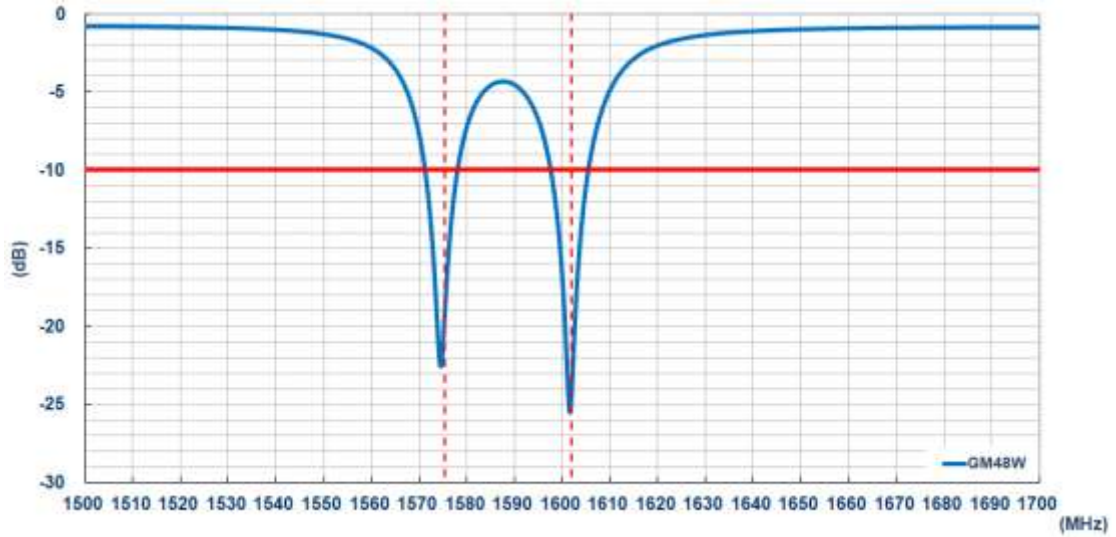

Efficiency:

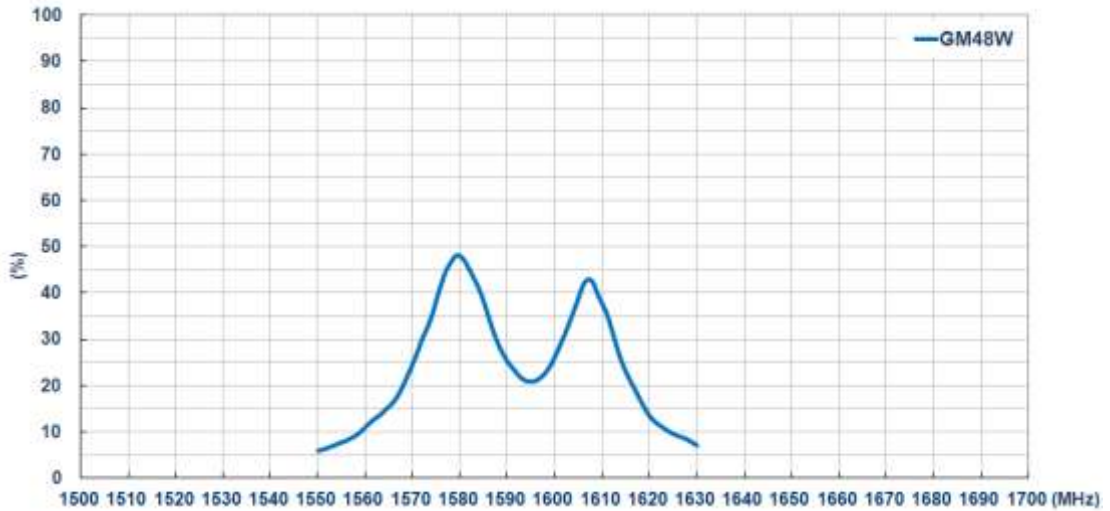

Average Gain:

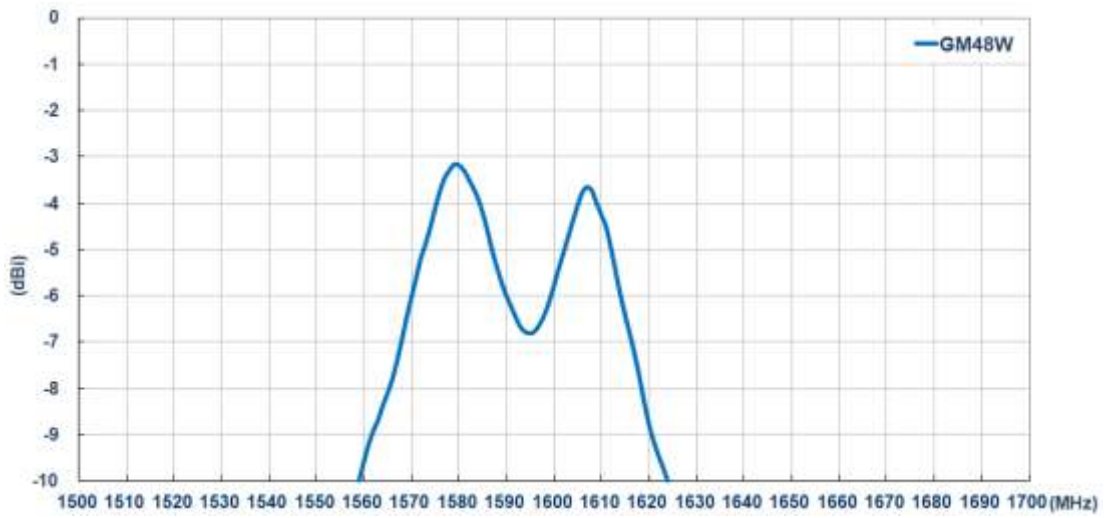

Peak Gain:

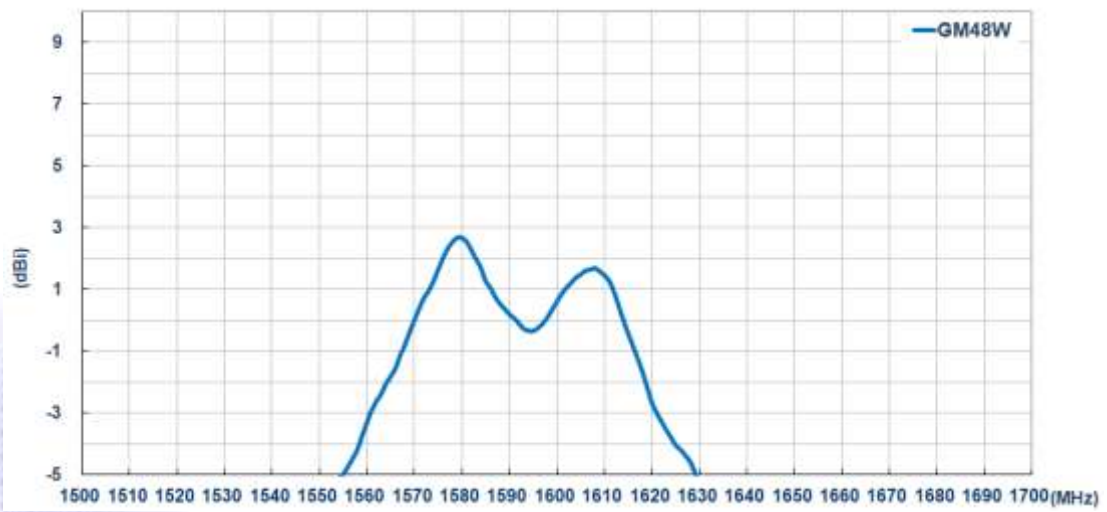

III. Antenna Radiation Pattern Measurement:

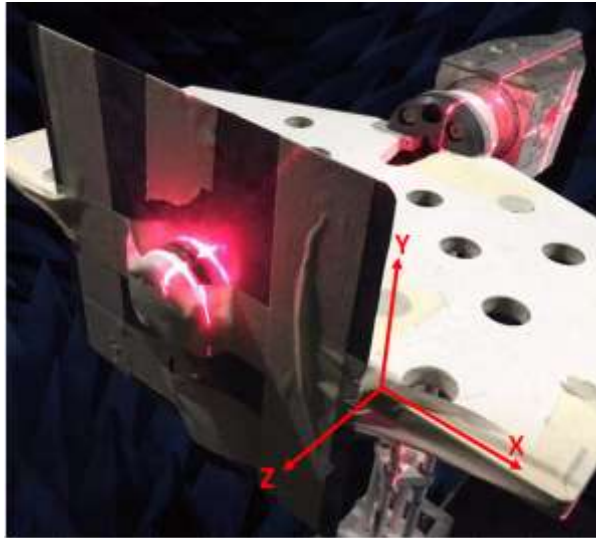

© San Jose Technology, Inc.
All specifications subject to change without notice.

IV. 2D Radiation Pattern

X-Y plane

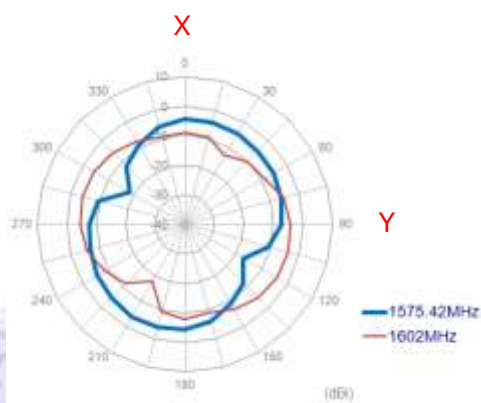

X-Z plane

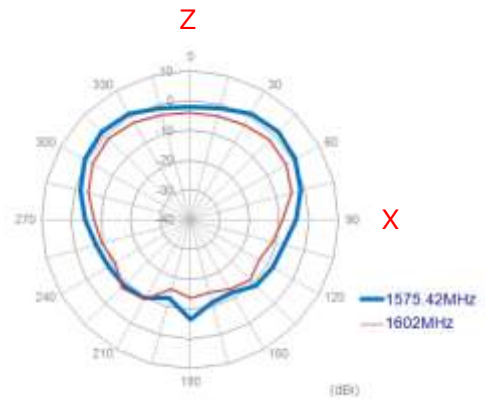

Y-Z plane

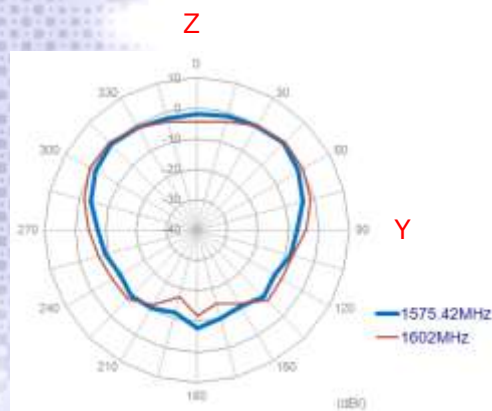

V. 3D Radiation Pattern

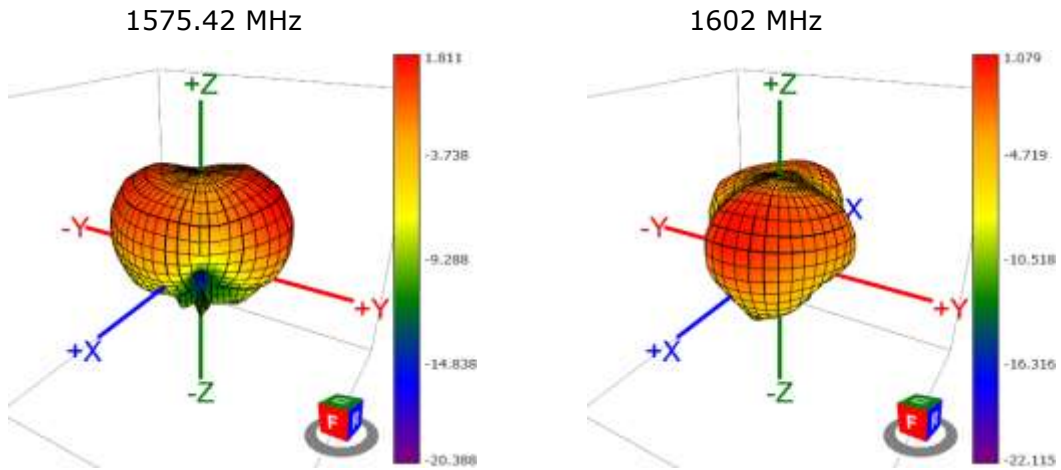

© San Jose Technology, Inc.
All specifications subject to change without notice.

VI. Mechanical Drawing (Unit:mm):

